

EN 14785
BlmSchV Stufe 2
Regensburger BStV / Aachener BStV / Munchener BStV
ART.15a B-VG / Klimafonds / LRV
5 stelle DM.186 / Conto Termico 2.0



(Max) nominal heat output	17.7 kW
(Max) nominal heat output (H₂O)	12.7 kW
Minimum heat output	4.4 kW
Minimum heat output (H₂O)	2.3 kW
Efficiency at Max	94.8 %
Efficiency at Min	95.9 %
Energy Efficiency Class (A++ / G scale)	A++
Energy Efficiency Index (EEI)	134 %
Seasonal space heating energy efficiency (η_s)	92 %
Temperature of exhaust smoke at Max	107 °C
Temperature of exhaust smoke at Min	55 °C
Particulate/OGC / Nox (nominal at 13%O₂)	10 - 2 - 99 mg/Nm³
CO at 13% O₂ at Min and at Max	0.017 - 0.009 %
CO₂ at Min and at Max	5.9 - 13 %
Maximum operating pressure	2 bar - 200 kPa
Recommended draught at Max power	10 Pa
Minimum draught allowed for minimum power	2 Pa
Mass of smoke at Min and at Max	5.4 - 10.6 g/sec
Hopper capacity	43 l
Fuel dimensions	Ø 6mm L 3 ÷ 40mm
Hourly consumption at Min and at Max	1 - 3.9 kg/h *
Autonomy at Min and at Max	28 - 7 h *
Heatable volume m³	322 - 506 - 885 **
Combustion air inlet	Ø 50 mm
Air inlet	80 cm²
Smoke outlet	Ø 80 mm
Nominal electrical power (EN 60335-1).	126 W (max 370 W)
Supply voltage and frequency	230 Volt / 50 Hz
Net weight	190 kg
Distance from combustible material (back/side/under)	20 mm / 200 mm / 0 mm
Distance from combustible material (front/ceiling)	750 mm / 1000 mm

* Data that may vary depending on the type of pellets used.

**Heatable volume based on the requested power per m³ (respectively 55-35-20 W/m³)

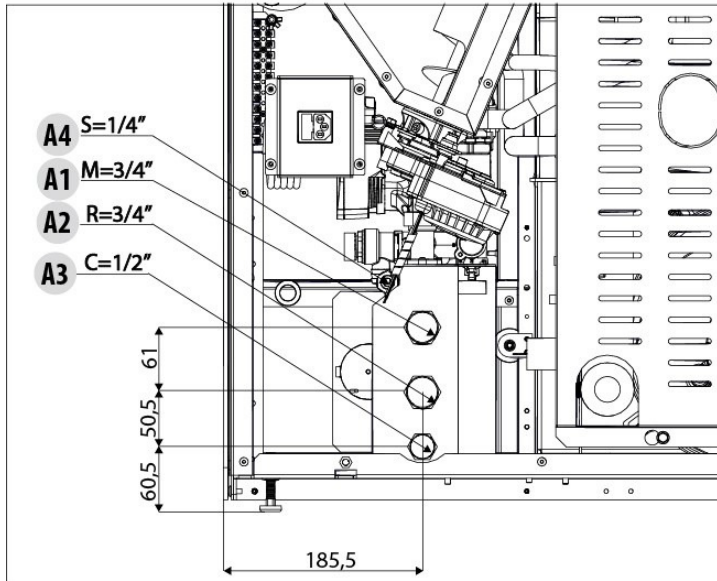

- A1 = Heating water delivery
- A2 = Heating water return
- A3 = System filling/Domestic cold water inlet
- A4 = System outlet
- A5 = Domestic hot water outlet



It is strongly recommended to wash the entire system before connecting it in order to get rid of residues and deposits. Always install shutters in the system leading to the stove so as to disconnect it from the hydraulic system should it be necessary to move it, or when it requires routine and/or special maintenance. Connect the stove using flexible pipes so that the stove is not excessively constrained to the system, and to allow slight movements.